

VERSION 1.1

MAY 20, 2020



POCKET POWERBOX ADVANCE

PRODUCT MANUAL

BY PEGASUS ASTRO

INTRO

Thank you for purchasing our Pegasus Astro – Pocket Powerbox Advance. **Pocket Powerbox Advance** (in short PPBADV) is suitable for the “grab and go” astronomer / photographer. Device can provide up to 12 Amps of electric current, has four 12V outputs, a quad port USB3 Hub, two dew heater channels, a variable voltage output and an external environmental sensor to constantly monitor relative humidity and ambient temperature. Controller can adjust the dew heaters consulting the sensor temperature / humidity values and calculating the dew point of the environment.

CONTROLLER CARE

- Controller is protected from moisture but it is not waterproof and it should be kept clean and dry.
- Excessive moisture for long periods of time can damage electronics and connectors.
- Do not allow solvents or chemicals to come into contact with the device.
- Store controller indoor in a dry room when not in use for long time.
- Do not touch the internal components as they may get hot when in use.

DESIGN OVERVIEW

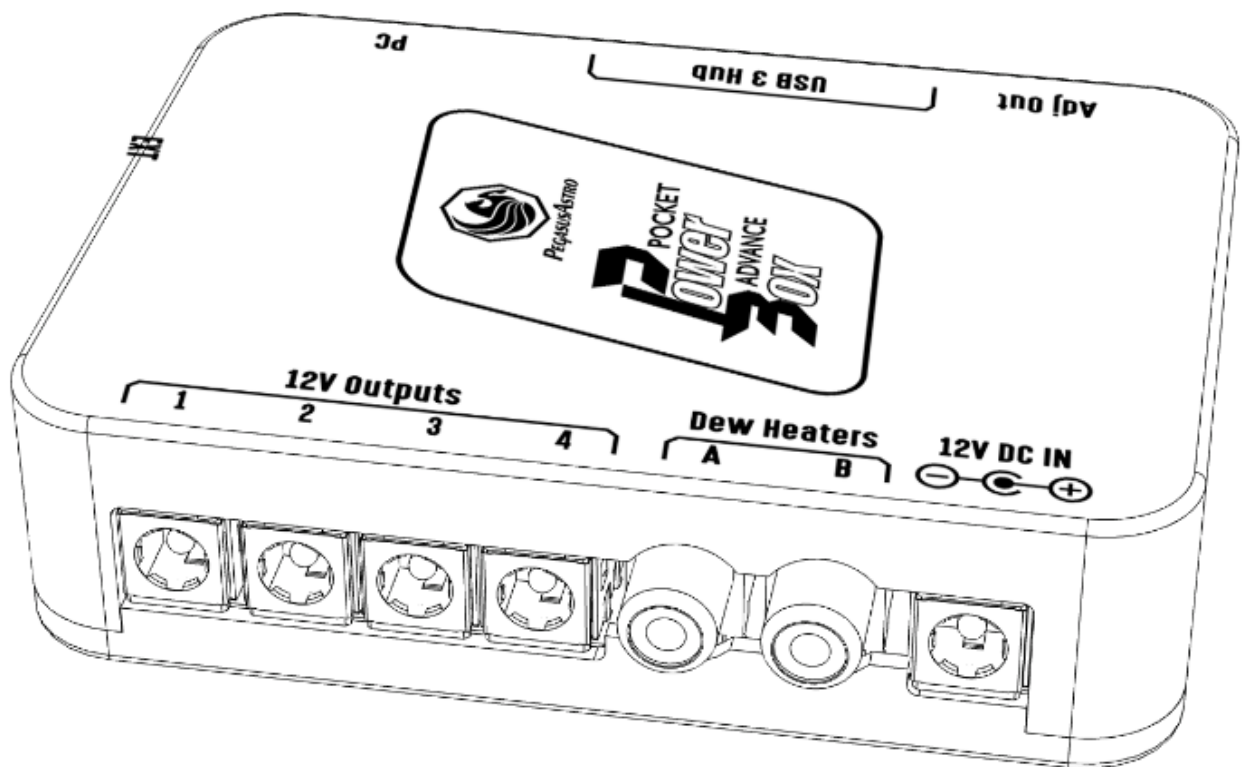

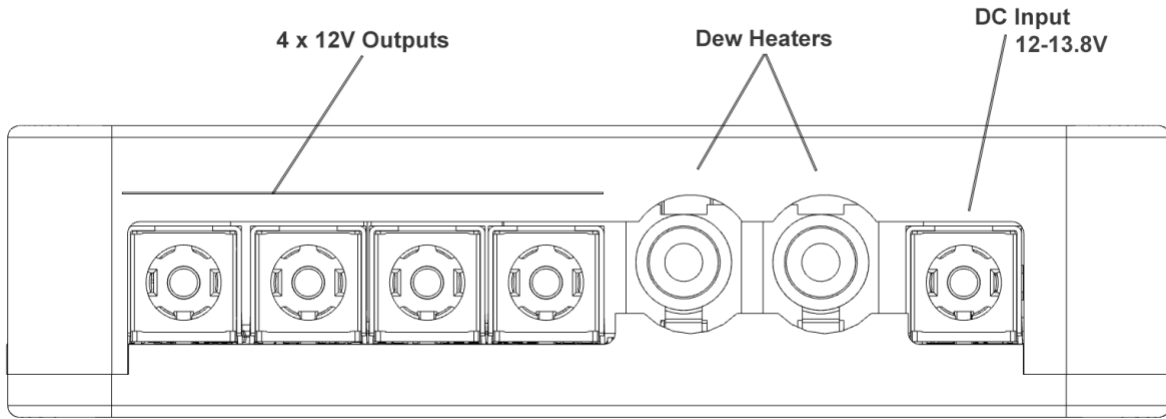

Front View

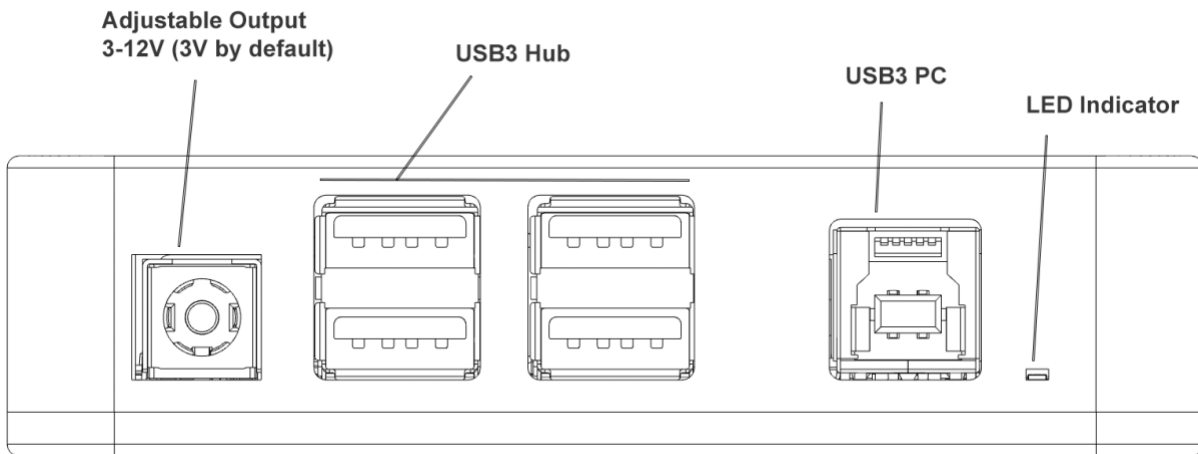

Back View

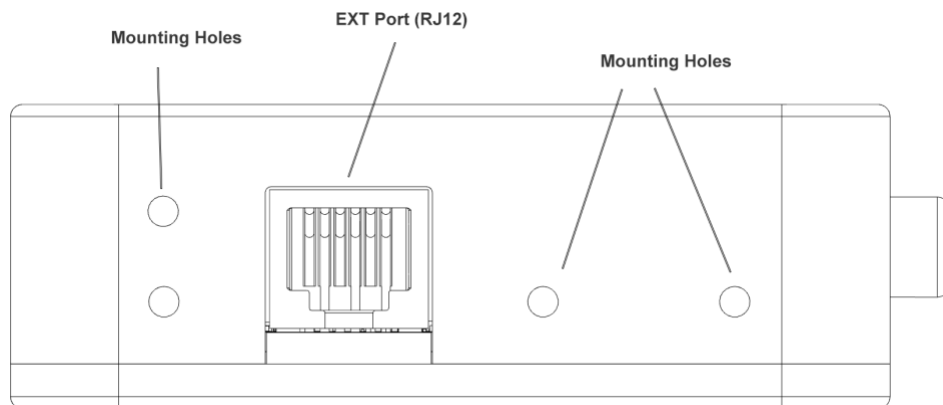

Side View

What is inside the box



Pocket Powerbox Advance



1 x DC Cable (2.1mm) to Cigarette Lighter (8A fused)



4 x Power Cables (1 meter)



1 x USB2 Cable Type B (1.8m)



1 x Environmental Sensor (RJ12)

OPERATING INSTRUCTIONS

1. Plug the external environmental sensor into EXT port.
2. Plug the USB3 cable to the device and to your computer.
3. Plug the power supply (battery or power pack) into the "12V DC IN" socket. We strongly advise to use our certified power supply that can provide DC 12V and 10 Amps.
4. Device will boot after three seconds and the LED will turn solid blue. This means that firmware was loaded successfully and the controller is now fully operational.
5. Default settings provide DC pass through voltage to all four outputs. Dew Heater outputs are configured to auto-dew by default.
6. Download USB drivers, standalone software or ASCOM drivers from pegasusastro.com/support in order to connect to the device.

POWER INPUT

Controller can accept voltage ranges from DC 12V – 14.5V *.

>> We strongly recommend you use our certified “Pegasus Astro 12V power supply” <<

A 13.8V lead (or calcium/lead) battery is also recommended. Please use a power supply that can provide at least 6 Amps of current. For your observatory needs you might need up to 10 Amps of current.

Under no circumstance exceed DC 15.0V input as you will cause a severe damage controller electronic board

Unit has been designed with reverse polarity protection. If you accidentally reverse the power source polarity, the unit will cut the power. The controller is fitted with a 2.1mm DC power connection which powers on the unit.

Insert the 2.1mm plug on the DC power cable. Controller will initialize and the status LED will turn solid blue after 4 seconds. *(The 4 seconds wait time duration is on purpose for a new firmware upload process)*

* Above 14.5V the Pocket Powerbox will shut down all 12V output ports to save your precious equipment from overvoltage.

DATA CONNECTIVITY

A USB3 Type B port at the side of the unit accepts the USB cable for PC connection. A 1.8m USB3 type B cable is supplied in the package.

USB3 HUB

A powered USB3 Hub at the back of the device provides 4 x USB3 SuperSpeed Ports.

Hub supports Hi-Speed (HS), Full Speed (FS) and Low Speed (LS). The new SuperSpeed hubs operate in parallel with the USB 2.0 controller, so 5 Gbps SuperSpeed data transfers are not affected by slower USB 2.0 traffic.

Please note that only 3 out of 4 USB Ports are compatible to USB2 devices (as shown below).

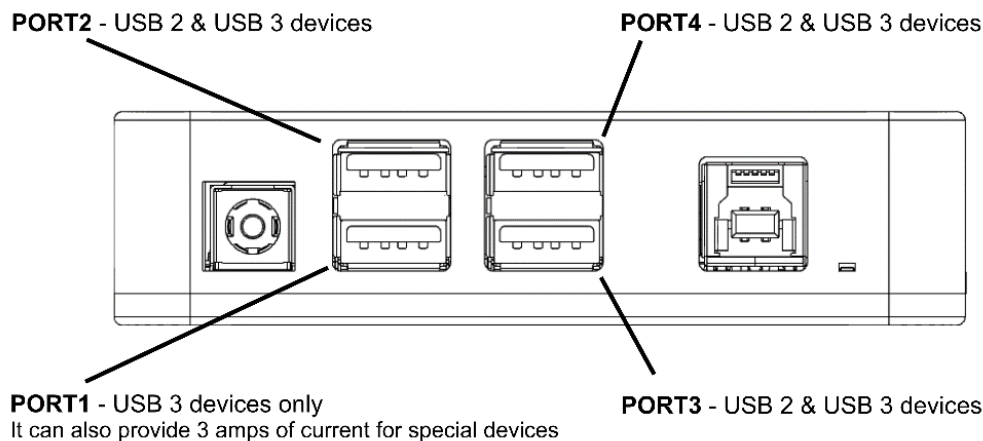

12V POWER OUTPUTS

Pocket Powerbox device has:

- Four (4) 12V DC unregulated outputs. All outputs are driven by a single Smart Mosfet, capable to deliver up to 10 Amps of current (in total). This mosfet incorporates a broad range of smart features like diagnose and protection. The 12V Channel can be switched ON/OFF via software.

Each 12V power output has the following specification:

Voltage type	Port
12V-13.8V DC unregulated	2.1mm DC Power Jack / Center Positive

DEW HEATER OUTPUTS

Device has two (2) channel dew heater outputs. Like power outputs, each dew heater output includes a Smart Mosfet type, capable to deliver up to 5 Amps of power per channel.

Auto-Dew: A smart function exists in the controller's firmware: The controller consults the environmental readings of the dew point and automatically adjust power of the Dew Heaters. This functionality can be switched on / off from the software and **the setting is stored in controller's memory.**

Note 1: Auto Dew functionality is turned on by default

Note 2: Dew heater outputs are also suitable to light a flat panel or turn your telescope's fans.

Voltage type	Port
12-13.8V DC, PWM - Duty Cycle %	RCA Female Jack / 5 Amps Each

BUILT IN POWER SENSORS

- Main output channel (4 x 12V) incorporates a current meter. A Smart Mosfet is capable to diagnose the power consumption of these 4 ports and provide protection against overload, over temperature and short circuit.
- Each Dew Channel incorporates a current meter ports and provide protection against overload, over temperature and short circuit.
- A DC voltmeter exists after controller's power input. (Measures 5 – 15 Volts).
- A current meter exists after controller's power input. (Measures 0 – 20 Amps).

ADJUSTSTABLE OUTPUT

A 2.1mm output provide 3-12V and 3A of current (max). This **regulated** output is configured to 3V by default. You can adjust the voltage of this output via the supplied software to **3, 5, 8, 9 or 12** Volt levels. Setting is stored in controller's memory and is automatically retrieved during boot.

You can use a wide range of our Battery Couplers (NIKON / Canon / Fuji / Sony) to provide constant power to your DSLR / Mirrorless camera. If you use this output for battery couplers you **must set it to 8 Volts**.

Voltage type	Port
3-12V DC regulated	2.1mm DC Power Jack / Center Positive

Adjustable Output can turn ON/OFF via software

ENVIRONMENTAL SENSOR

The stock probe is an external temperature / humidity sensor which is attached to the controller. It comes with length of 50cm cable. Probe measures:

- 0 to 100% humidity readings with 2-5% accuracy
- -40 to 80°C temperature readings $\pm 0.5^\circ\text{C}$ accuracy

The unit automatically detects the presence of the probe and polls for temperature readings every 15 seconds.

A RJ12 socket connects the temperature/humidity sensor with the Pocket Powerbox Advance controller.



RESET WATCHDOG

A watchdog resets the device if for any reason there is no response from the controller after two (2) seconds. A neat feature in the unlikely event of a microcontroller freeze – when have a remote observatory and you need to be sure that everything works as expected.

STATUS LED

A blue colored LED is fitted on the right front side of the unit. The light pattern displayed by the led indicated the status of the device. The led can be turned on / off from the software at your demand.

Permanently Light	Device is up and running
Flashing Light (4 times every 4 sec)	Device entered to firmware upload
Flashing Light (once per second)	A power issue (overvoltage) exists and controller had already shut down the ports. Check diagnose message in software
Permanently Off	Controller not operational or LED switched off from software

MOUNTING

Device has 4 threaded holes (M3) on each side to allow mounting of bracket accessories.



RECOMMENDATION.

- It is wise to select and use good quality and short length USB cables.
- Do the same for power cables. Long and thin power cables will have an effect of voltage drops. This can cause issues to your camera (CCD or CMOS) image quality or mount tracking.
- Make sure you use a good quality DC input socket with a thick power cable (1.5mm each pole). Verify there are no gaps that can cause power disconnect
- Pay extra attention if you are using a “step up voltage converter” in the DC input. You need at least 6 Amps to power all of your devices. (We don't recommend step up converters – buy a good battery or a check our certified 12V/10A power supply).





DIMENSIONS

Size (Width, Depth, Height)	100mm x 73mm x 25mm
Weight	300 grams

FREQUENTLY ASKED QUESTIONS

Question	Answer
What kind of power supply do I need?	We strongly suggest to use our certified 12V/10A power supply. Cheap units might lead to voltage drops on high load and ripple effect. This will cause issues and artifacts to your precious CCD / CMOS Camera.
What type of cable do I need to use for input?	If you are going to make a custom input cable notice that you need at least a AWG 17 cable. Make also sure that you do not exceed 2meters (6feet) to reduce voltage drops.
I would like to use the Pocket Powerbox to my remote observatory. What if the device freezes for some reason?	We have good news for you. The device has a hardware watchdog and resets itself if the microcontroller is not responsive after 2 seconds
My observatory is in a very cold place. Is there any issue with the electronics of the device?	Electronic components were selected to support temperature ranges from -40 to +80 °C.
What if I accidentally reverse polarity?	Pocket Powerbox has an input reverse polarity protection. Device will not power on and of course will not allow any voltage to flow to outputs.
Can I upgrade the firmware?	Of course, device has been designed to support firmware upgrade for future features or bug fixes.

Optional Accessories

 <p>Battery Couplers for DSLR /Mirrorless Cameras (Wide range of types for NIKON/Canon/Sony/Fuji cameras)</p>	 <p>Power cable for Skywatcher EQ8 or Power cable for Skywatcher EQ6R / EQ6-AZ</p>	 <p>Power Supply Unit 12v/10A 2.1mm Plug</p>
 <p>External Motor Controller</p>	<p>Dovetail Brackets (Coming Soon)</p>	<p>Mini Factor PC Top Plate (Coming Soon)</p>

Device is covered by two (2) years warranty

Designed and Assembled in Greece